



# 目 录

一、运输作业组织与管理模块..... 2

二、仓储与配送作业组织与管理模块..... 34

三、国际物流作业组织与管理模块..... 150

四、 快递物流作业组织与管理模块.....	213
-----------------------	-----

湖南商务职业技术学院物流管理专业学生技能考核题库

## 一、运输作业组织与管理模块

○

○

○

--	--	--

○

○

--	--	--	--	--

## ( ) 任务描述

○

:

○

○





<input type="checkbox"/> <input type="checkbox"/>				<input type="checkbox"/> <input type="checkbox"/>				
<input type="checkbox"/> <input type="checkbox"/>								
						<input type="checkbox"/> <input type="checkbox"/> <input type="checkbox"/> <input type="checkbox"/>		





( ) 任务描述:

- 
- 
- 







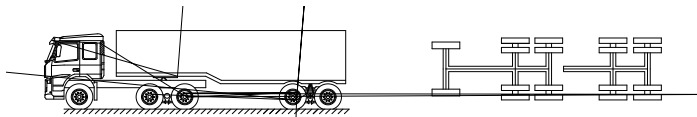
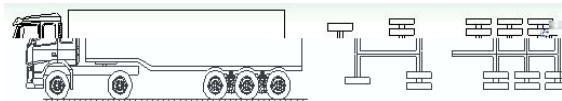

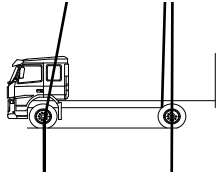
( ) 任务描述:







○

○

○

○

○



( ) 任务描述



**D**

<input type="checkbox"/> <input type="checkbox"/>			<input type="checkbox"/> <input type="checkbox"/>						
<input type="checkbox"/> <input type="checkbox"/>									
						<input type="checkbox"/> <input type="checkbox"/> <input type="checkbox"/> <input type="checkbox"/>			





**2**



**3**

**4**



( ) 任务描述

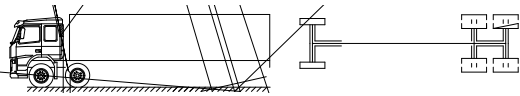
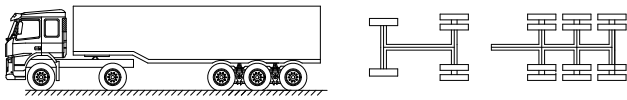
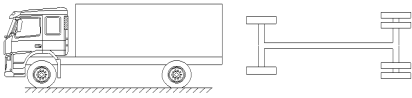







( ) 任务描述

- 
- 
- 
- 
- 





( ) 任务描述

( )

( )

		)	( )			

( )

( )

( )

( )

( )

○

( )		



Sailing Schedule from : Shenzhen,Shenzhen,Guangdong,China  
 To : Los Angeles,Los Angeles,CA,United States  
 Origin City : Shenzhen,Shenzhen,Guangdong,China  
 Destination City : Los Angeles,Los Angeles,CA,United States  
 CY/DOOR  
 CY/DOOR

序号	航线	船名	航次	截关时间	装货港	预计离港时间	实际离港时间	卸货港
1	YPSW	YM UNISON	59E	2016-04-22 17:00	Yantian	2016-04-25		Los Angeles
2	SEA	NORTHERN JAVELIN	002E	2016-04-23 12:00	Yantian	2016-04-27		Long Beach
3	AAS2	CMA CGM LIBRA	095TXE	2016-04-25 16:00	Yantian	2016-04-28		Long Beach
4	YPSW	YM UBIQUITY	22E	2016-04-29 17:00	Yantian	2016-05-02		Los Angeles
5	SEA	C SCL PUSAN	117E	2016-04-30 12:00	Yantian	2016-05-04		Long Beach
6	AAS2	CMA CGM COLUMBA	097TXE	2016-05-02 16:00	Yantian	2016-05-05		Long Beach
7	SEA	COSCO NINGBO	069W	2016-05-06 11:00	Yantian	2016-05-08		Long Beach
8	YPSW	YM JIREBY...	50E	2016-05-06 17:00	Yantian	2016-05-09		Los Angeles
9	SEA	COSCO EXCELLENCE	027E	2016-05-07 12:00	Yantian	2016-05-11		Long Beach
10	AAS2	CMA CGM CENTAURUS	099TXE	2016-05-09 16:00	Yantian	2016-05-12		Long Beach
11	YPSW	YM MASCULINITY	32E	2016-05-13 17:00	Yantian	2016-05-17		Los Angeles



干货箱



	箱体内部尺寸			箱体内容积及载重量		箱门开度尺寸	
	L	W	H	Cu	P	W	H
20'	5898	2352	2393	33.2	21740/28230#	2340	2280
40'	12032	2352	2393	67.7	26630	2340	2280
HC	12032	2352	2698	76.3	26520	2340	2585

冷藏箱



	箱体内部尺寸			箱体内容积及载重量	
	L	W	H	Cu	P
20'	5444	2284	2267	28.5	21135/27160#
40'	11583	2284	2250	58.7	26580
HC	11583	2284	2556	67.9	26380

开顶箱



	箱体内部尺寸			箱体内容积及载重量	
	L	W	P	Cu	P
20'	5900	2330	2337	32.6	21740
40'	12025	2330	2337	65.8	26410

○

○

( ) 实施条件

( ) 考核时量

( ) 评分细则

1





( ) 任务描述



		<input type="checkbox"/>	<input type="checkbox"/>	<input type="checkbox"/>	<input type="checkbox"/>

<input type="checkbox"/>		<input type="checkbox"/>					
<input type="checkbox"/>		<input type="checkbox"/>					



( ) 实施条件



( ) 考核时量

( ) 评分细则





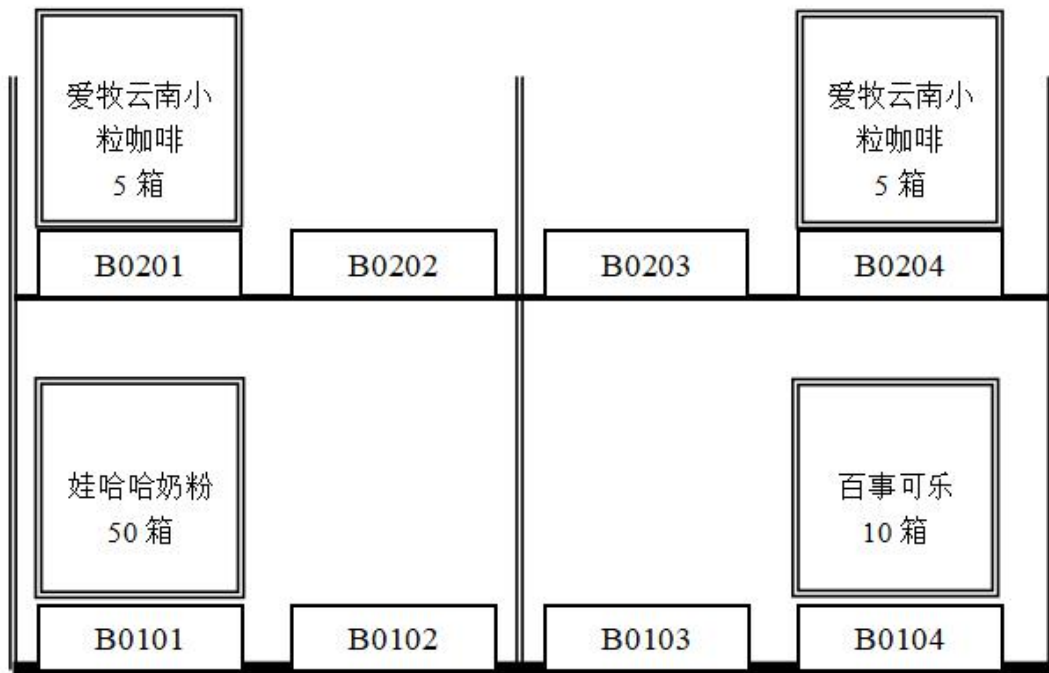
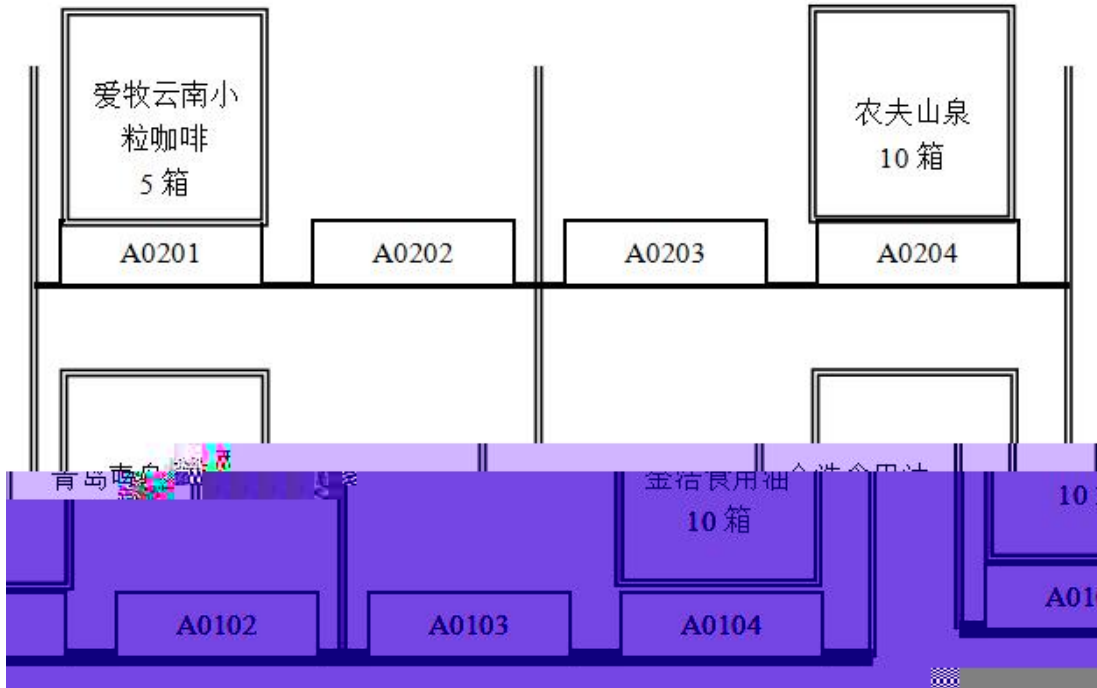



## 产品运输单

---



- 
- 
- 
- 
- 
- 
- 
-





80				





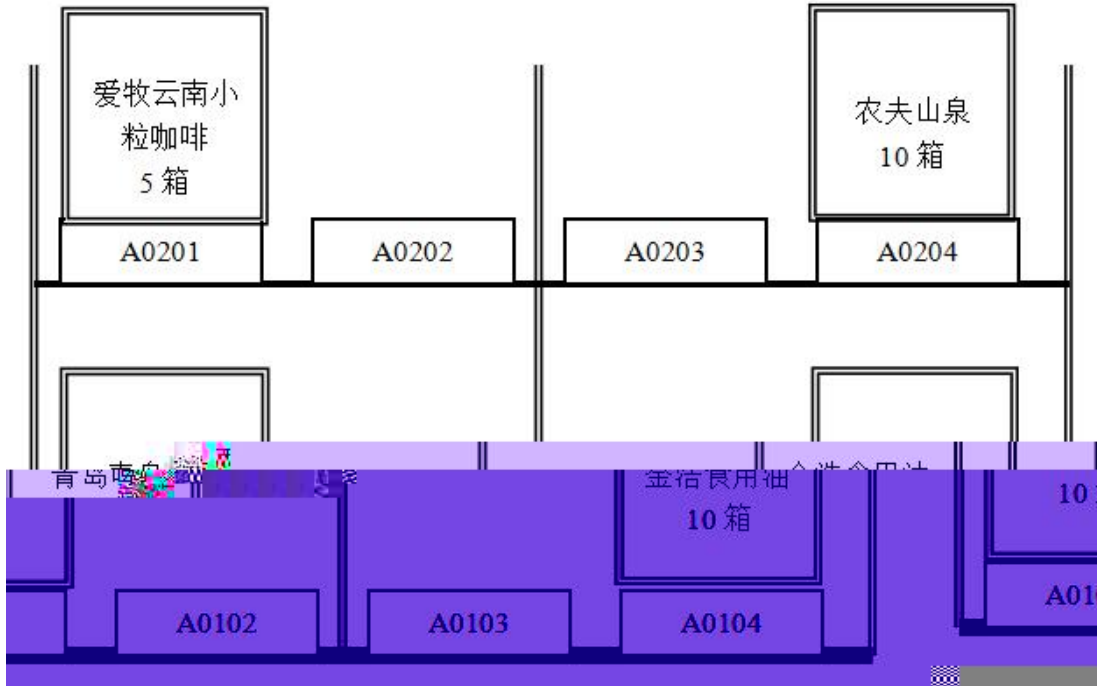



# 产品运输单

---



- 
- 
- 
- 
- 
- 
- 
- 









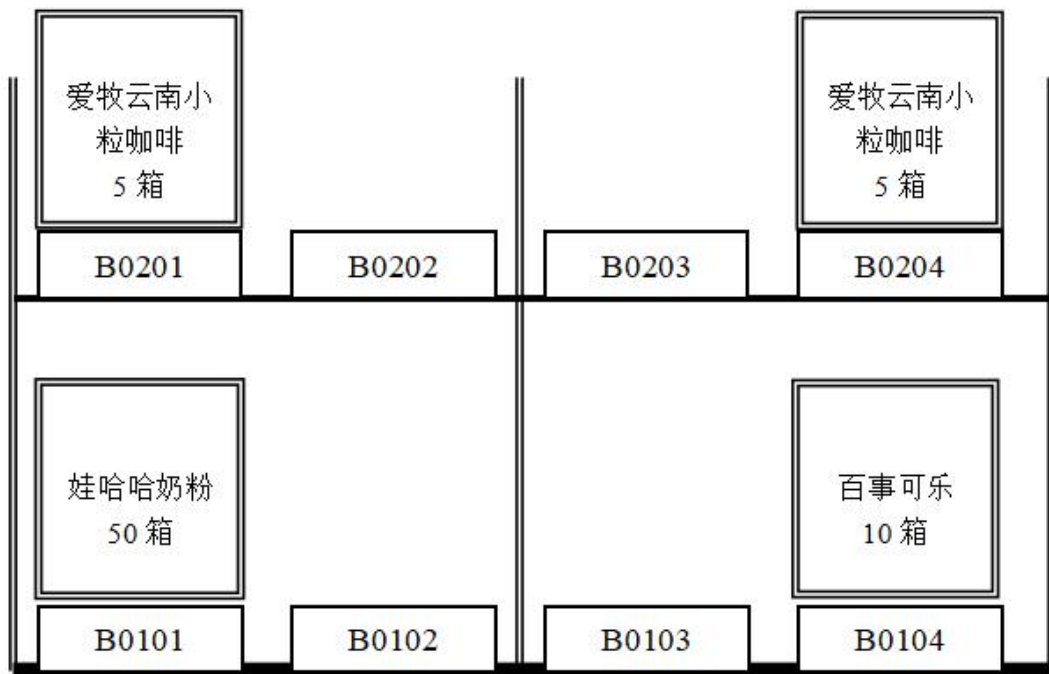
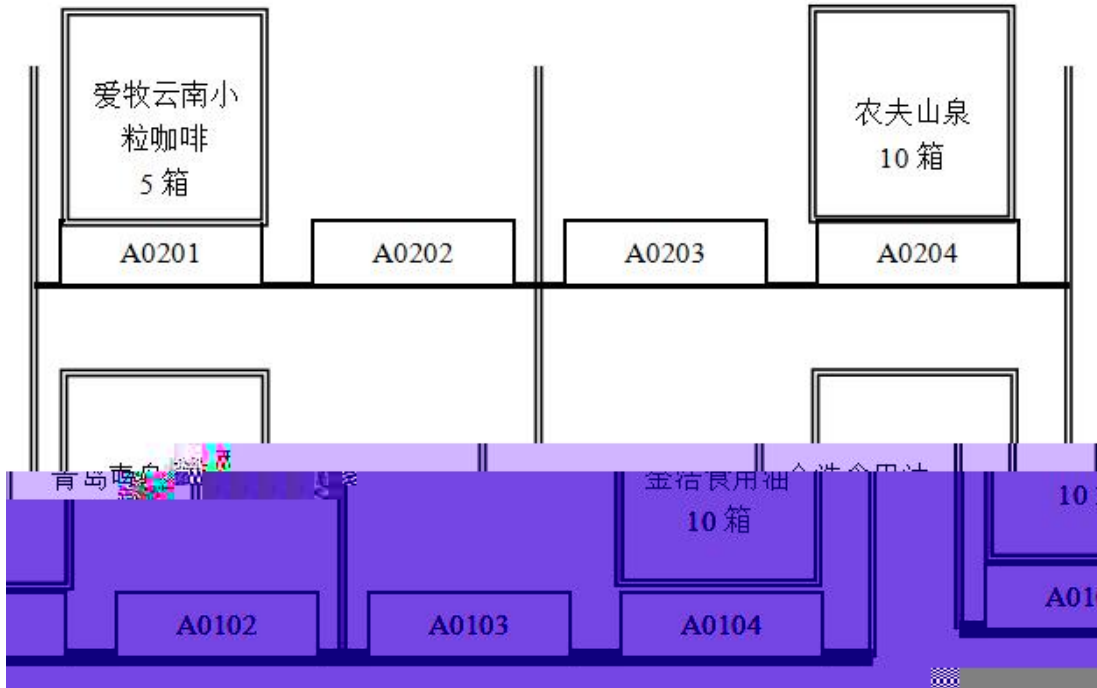

# 产品运输单

---



- 
- 
- 
- 
- 
- 
- 
-











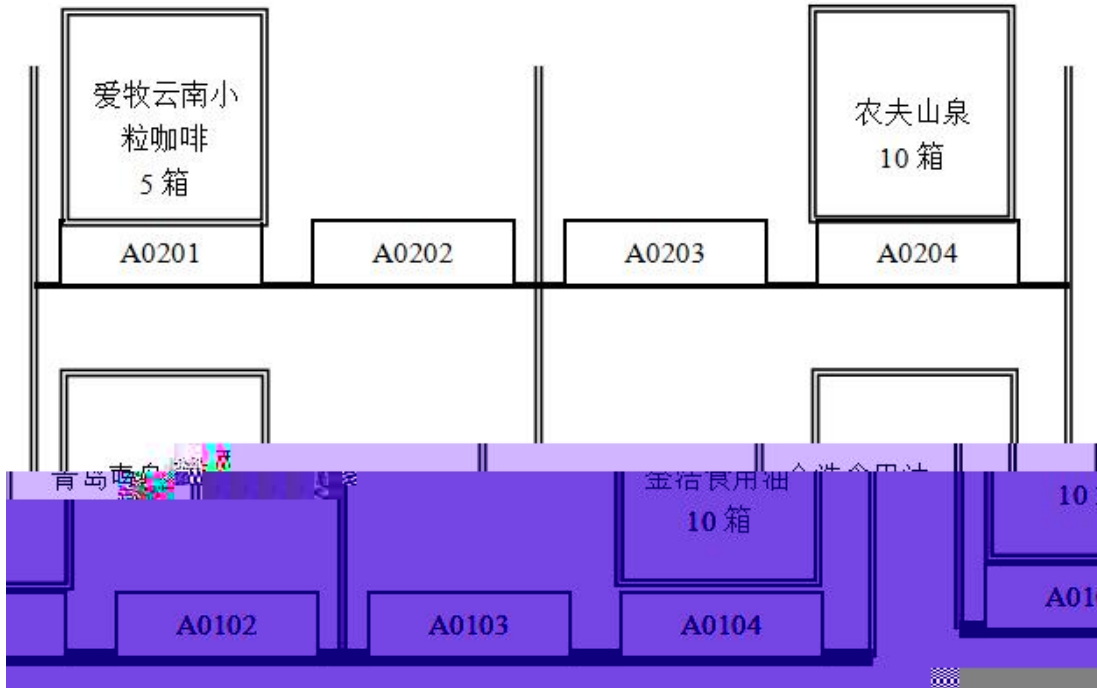

# 产品运输单

---



- 
- 
- 
- 
- 
- 
- 
-





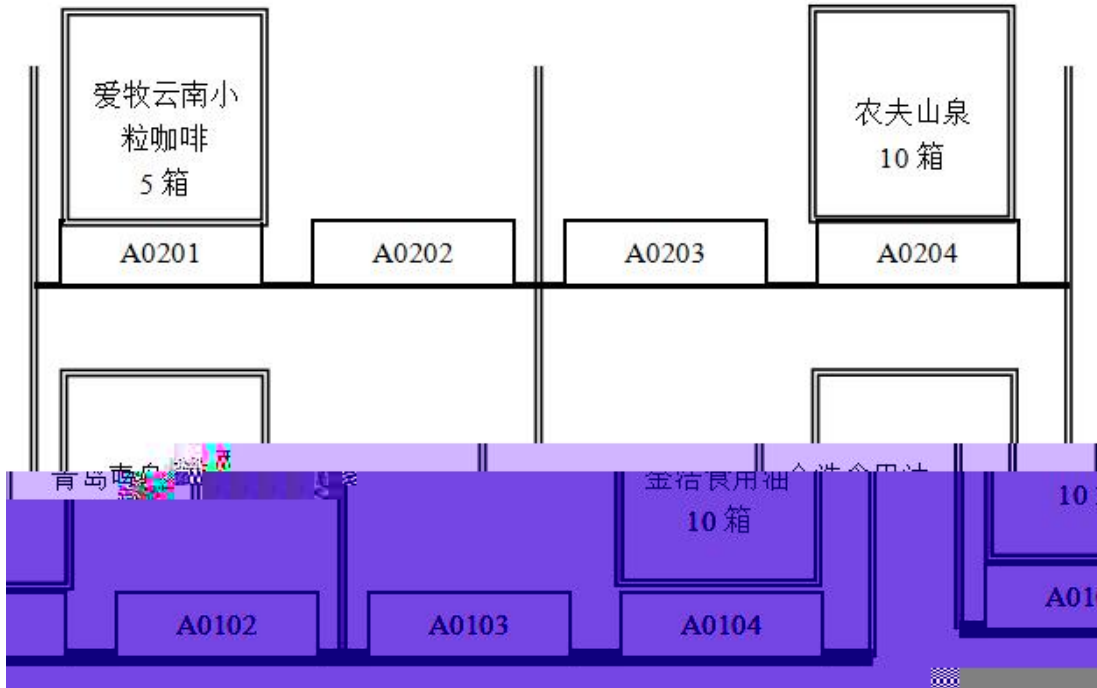

产品运输单

---



- 
- 
- 
- 
- 
- 

500r ÑÑ









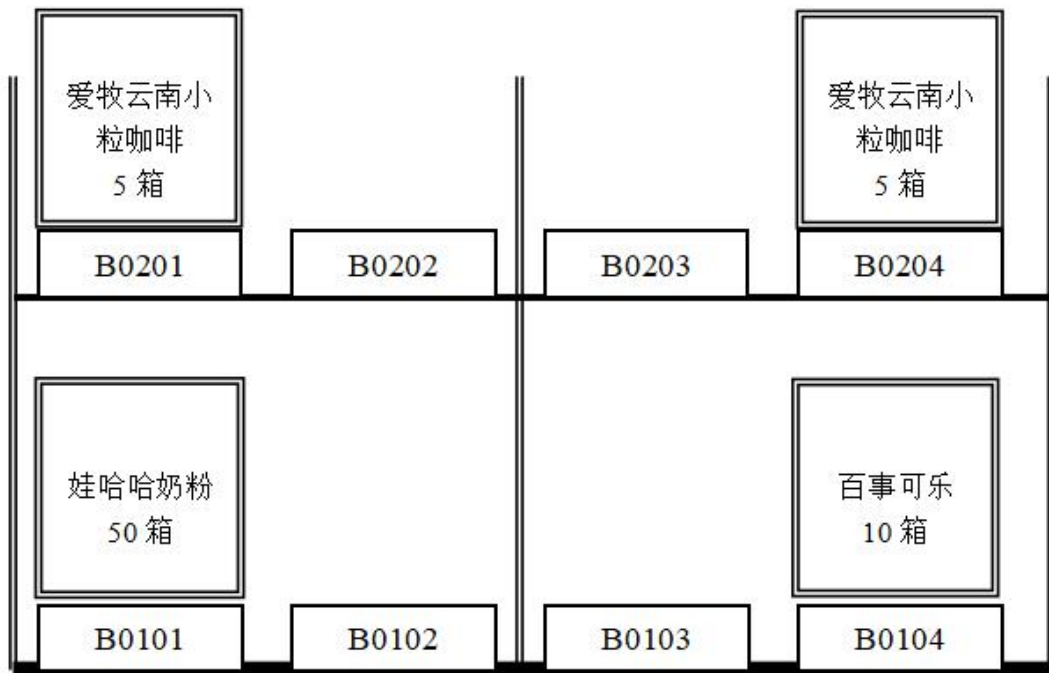
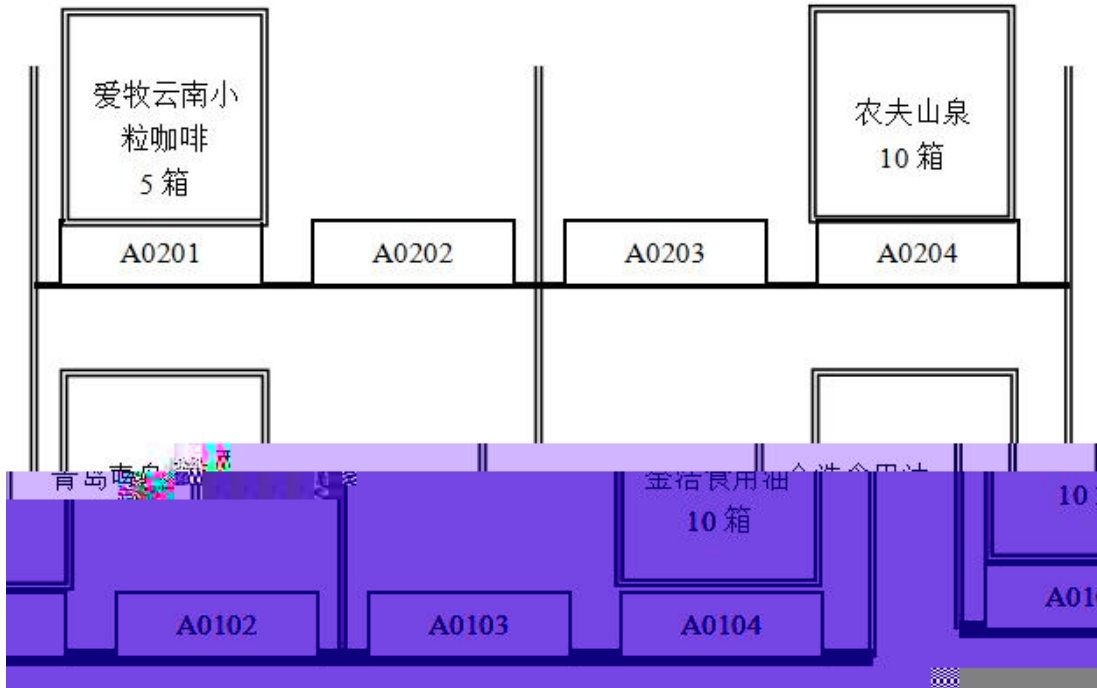

## 产品运输单







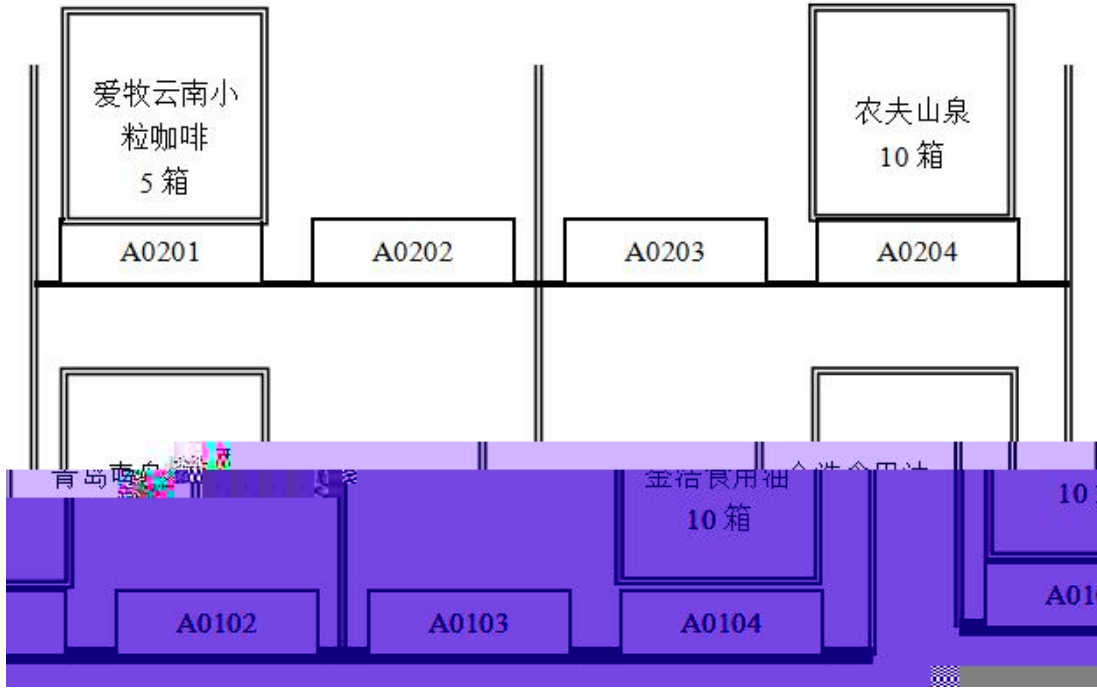

# 产品运输单

---



- 
- 
- 
- 
- 
- 
- 
- 
- 











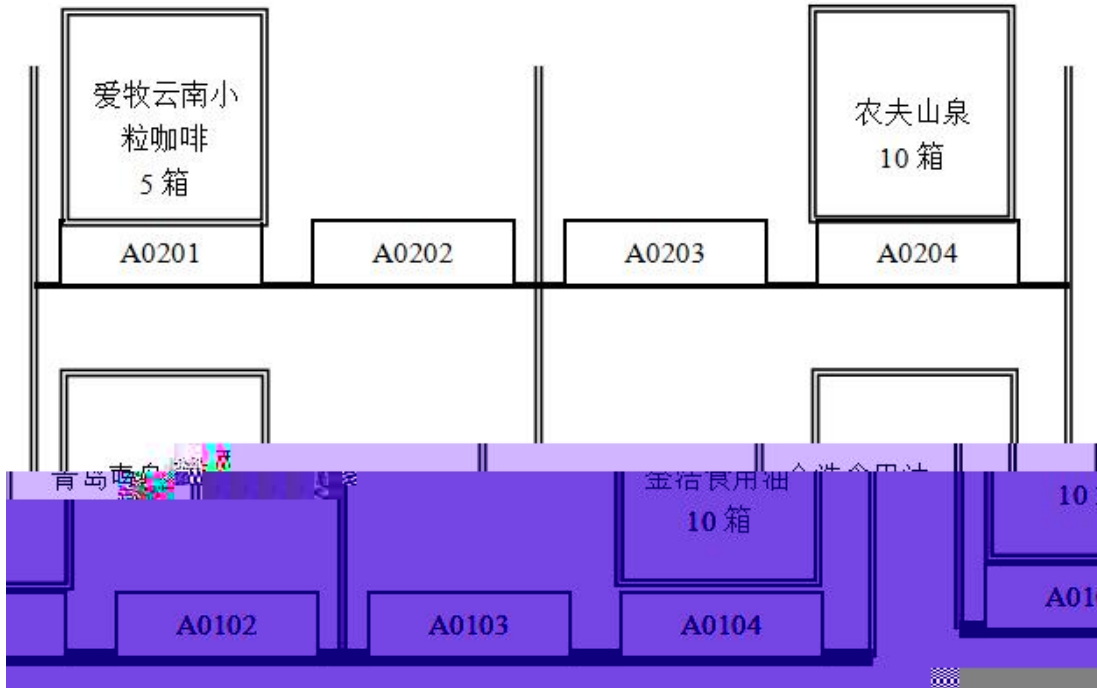

# 产品运输单

---



- 
- 
- 
- 
- 
- 
- 
- 
-









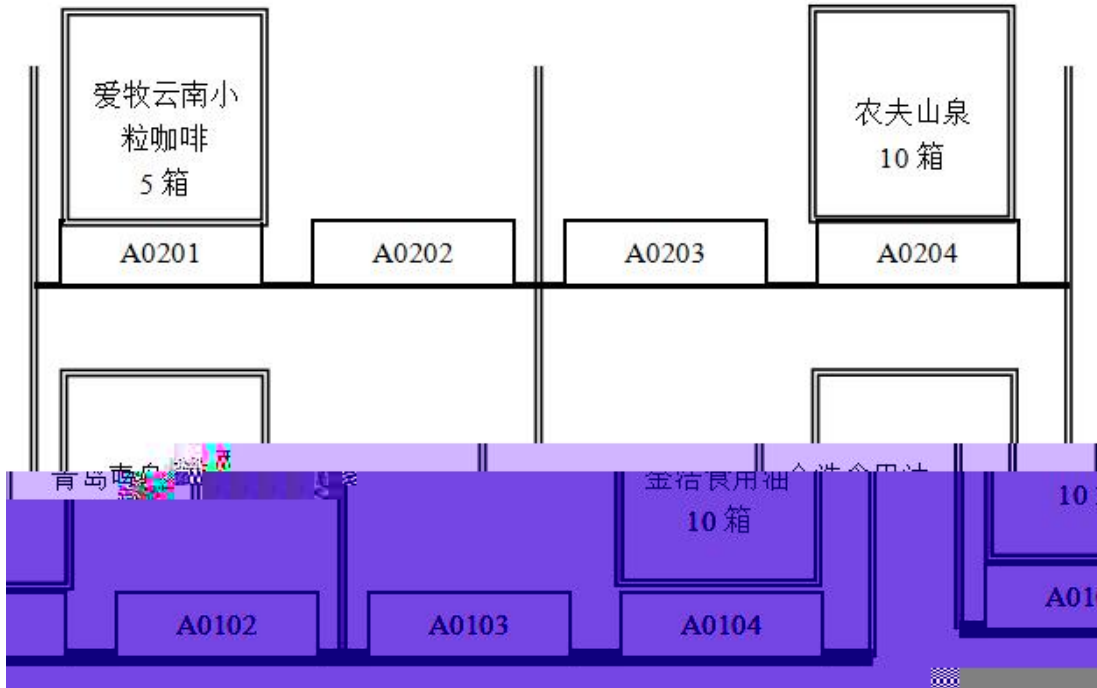

# 产品运输单

---



- 
- 
- 
- 
- 
- 
- 
- 
-











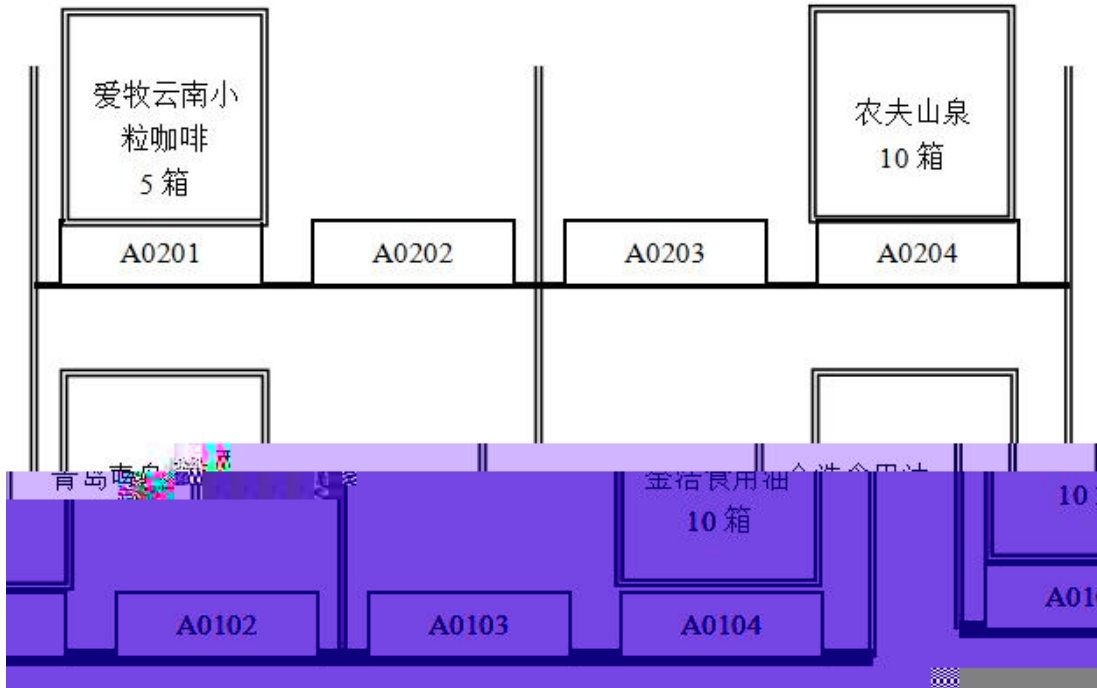

# 产品运输单

---



- 
- 
- 
- 
- 
- 
- 
- 







○

---



---



---

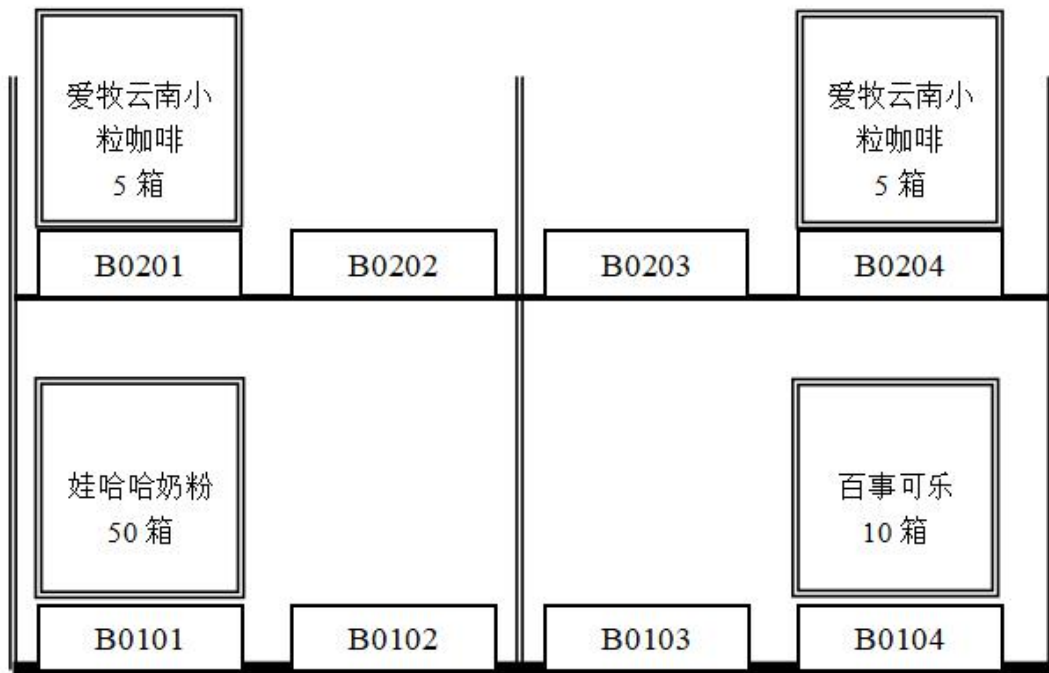
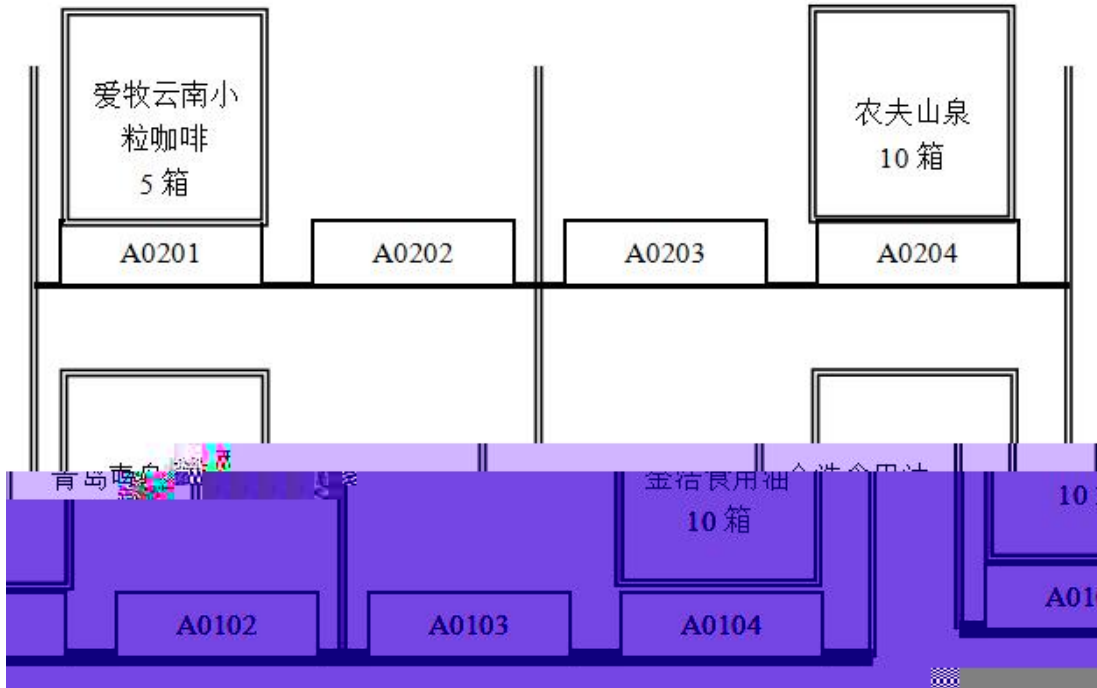





---

--	--	--	--	--	--

---



---

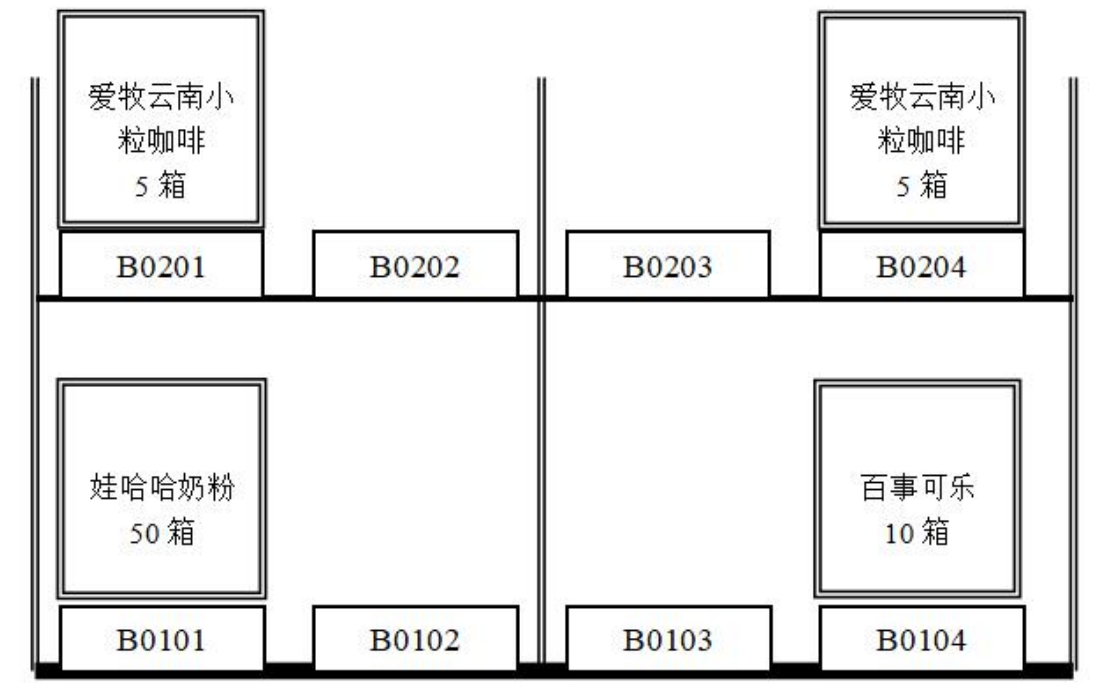
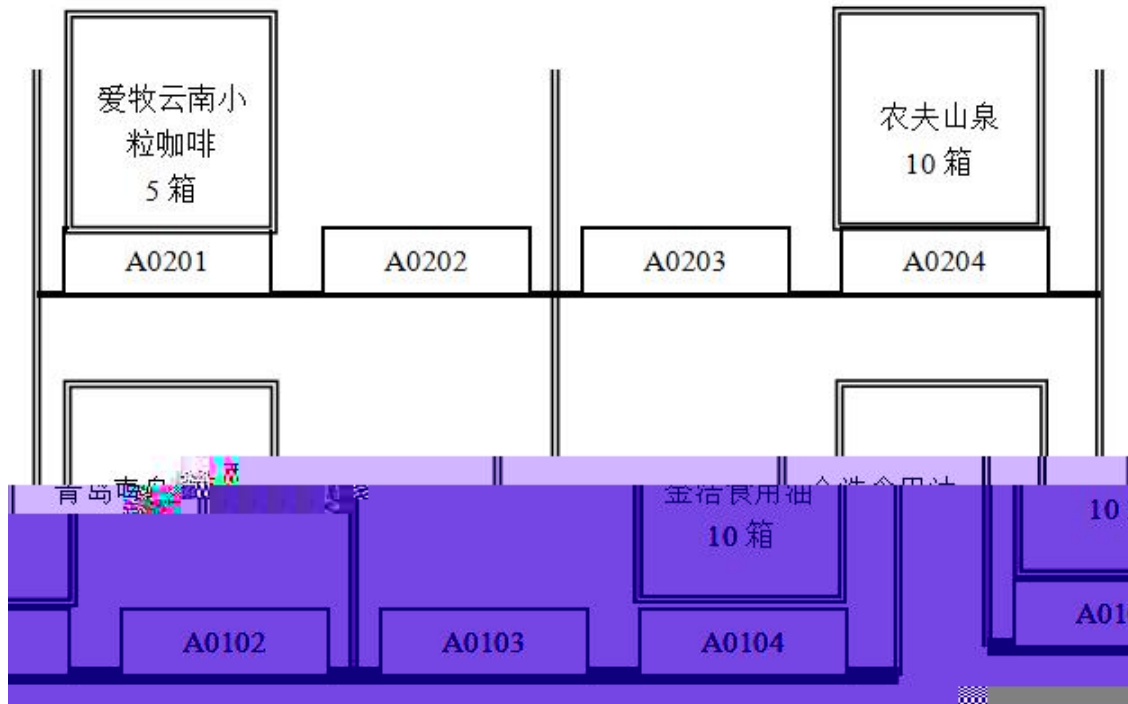

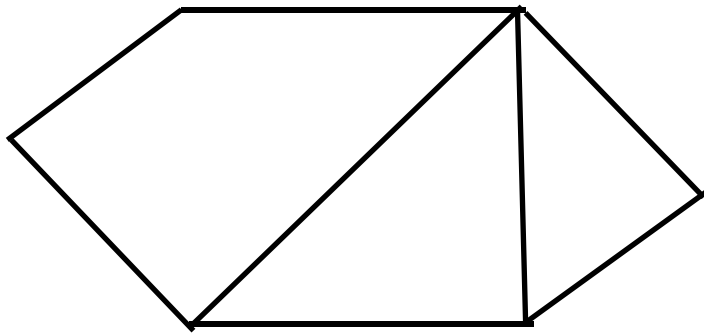







---

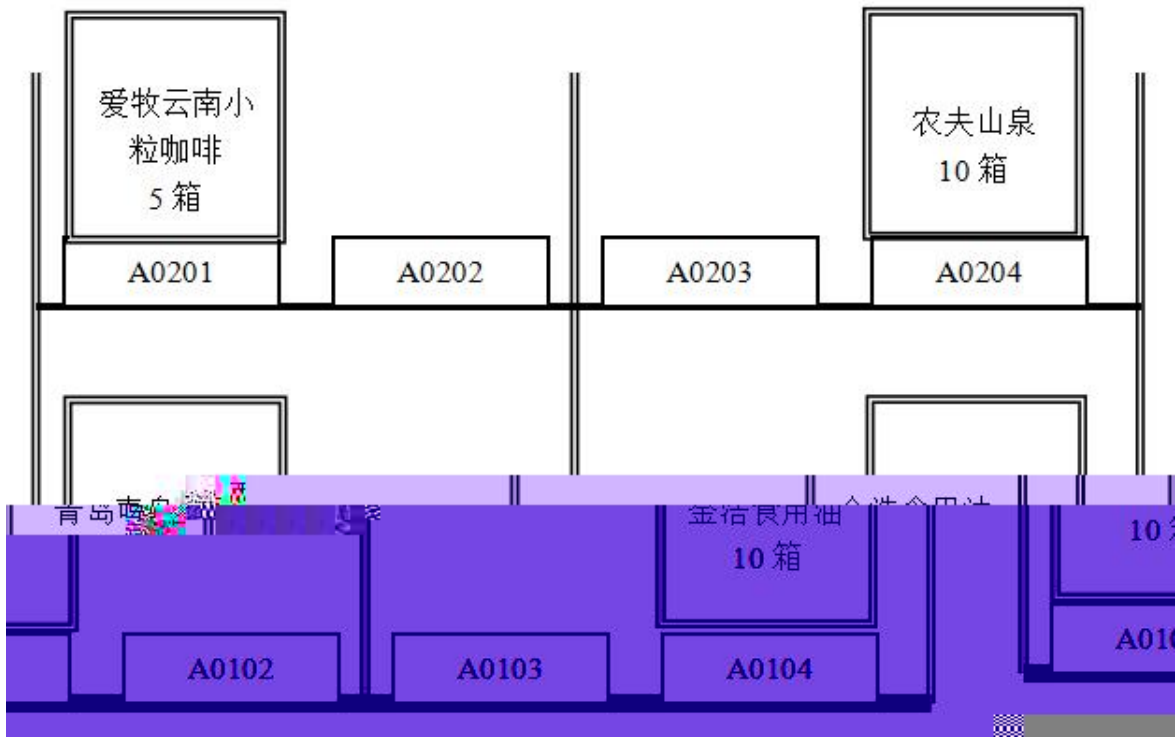

---







**1**

---



---



---

--	--

---



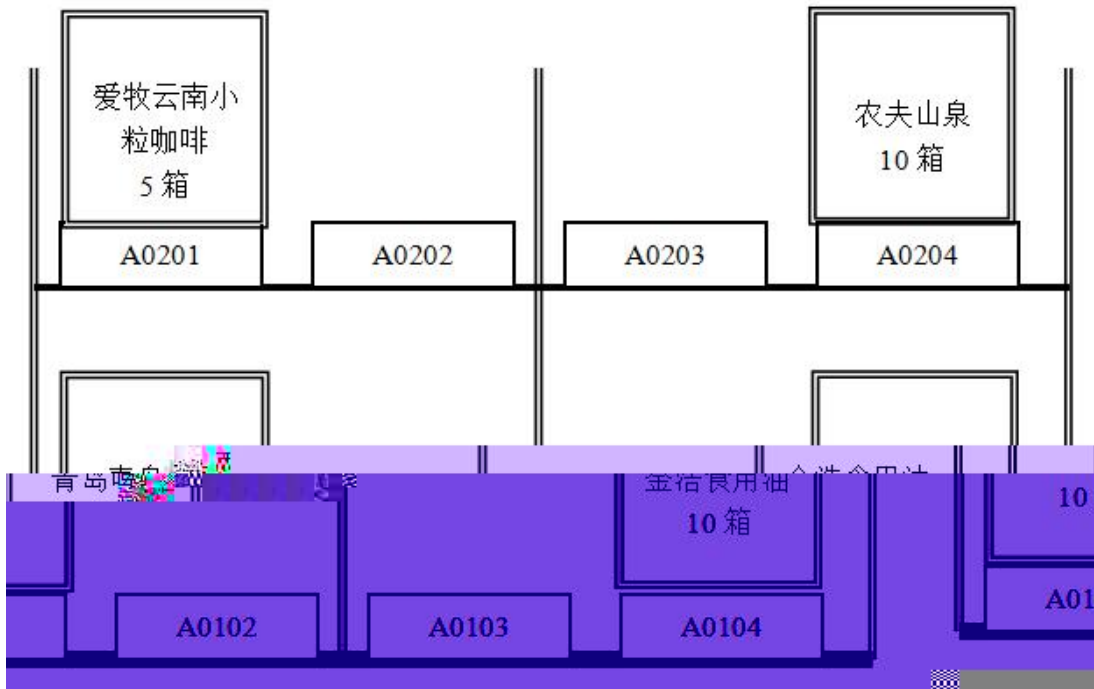





**1**

---

--	--	--	--	--	--

---



---













○

○













○

○











○

○













○

○

--	--











○

○







### 三、国际物流作业组织与管理模块



○



---

---

---

---





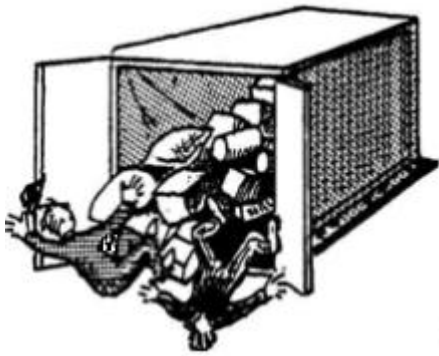
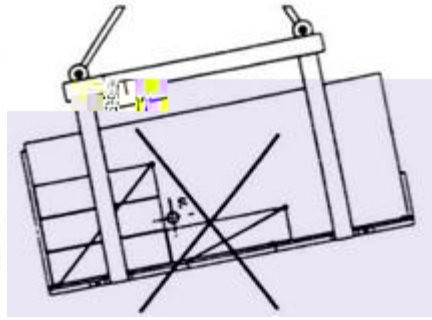





○

船公司	船名/航次	服务代码	航线	装船港/卸船港	启-达日期	天	挂港
Carrier			Lane	Load/Unload Port	ETD-ETA		Day
0	船名	MSC	MASTER	中国-香港	HONG KONG 香港	02/25(二)	
0	船名	地中海航运	HQ409E	中国-香港	KAOHSIUNG 高雄	03/15(六)	
5	船名	NYK	ITALIAN EXPRES	中国-东南亚	HONG KONG 香港	02/25(二)	
5	船名	日本邮船	S/024	中国-东南亚	BANGKOK 曼谷	03/02(日)	
0	船名	CMA-CGM	CMA CGM GEMINI	中国-非洲	XIAMEN 厦门	02/25(二)	
0	船名	达飞轮船	TXA49E	中国-非洲	DURBAN 德班	03/27(四)	
3	船名	KLINE	HYUNDAI PLATINUM	中国-中南美	SHANGHAI 上海	02/25(二)	
3	船名	川崎汽船	M/004W	中国-中南美	PARANAGUA 巴拉那瓜	04/09(三)	
6	船名	DMS	COSCO KAOHSIUNG	中国-澳新	HONG KONG 香港	02/25(二)	
6	船名	达发轮船	G/GFS46E	中国-澳新	NOUMEA 努美阿	04/02(三)	
6	船名	RCL	NOTA PERMASAN	中国-中东/波斯湾/印巴	QINGDAO 青岛	02/28(五)	
6	船名	青海船运	VPM114	中国-中东/波斯湾/印巴	MADRAS 马德拉斯	03/18(二)	
8	船名	ZIM	KUO HUNG	中国-港澳台	NINGBO 宁波	02/25(二)	
8	船名	以星轮船	311	中国-港澳台	HONG KONG 香港	03/15(六)	
9	船名	SAFMARINE	HEIKE P	中国-非洲	KAOHSIUNG 高雄	02/25(二)	
9	船名	比利时南航	1404	中国-非洲	MINDELO	04/05(六)	
1	船名	CSAV	CAP SAN NICOLA	中国-中南美	SHANGHAI 上海	02/25(二)	
1	船名	南航船运	S/01409	中国-中南美	RIO GRANDE 里奥格兰德	04/07(一)	
1	船名	OOCL	DRESDEN EXPRES	Pacific Atlantic (PAX)	SHANGHAI 上海	02/25(二)	
1	船名	东方海外	S/16E08	Pacific Atlantic (PAX)	HALIFAX 哈利法克斯	04/14(一)	



○  
○

BEIJING	CN		BJS
Y. RENMINBI	CNY		KGS
	1000000	1000000	120000
	1000000	1000000	120000
	1000000	1000000	120000
	1000000	1000000	120000
	1000000	1000000	120000



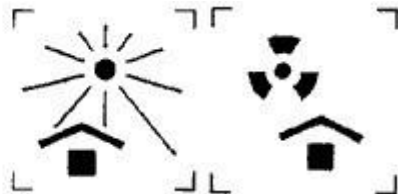

○





- 
-







---

---

---

---

---

---

集装箱设备交接单  
EQUIPMENT INTERCHANGE RECEIPT

OUT 出场

No.

用箱人/运箱人(CNTR. USER/HAULIER)		提箱地点(PLACE OF DELIVERY)																
发往地点(DELIVERED TO)		返回/收箱地点(PLACE OF RETURN)																
船名/航次(VESSEL/VOYAGE No.)	集装箱号(CNTR. No.)	尺寸/类型(SIZE/TYPER)	营运人(CNTR. OPTR)															
提单号(B/L No.)	危险品类别(IMCO CLASS)	箱封号(SEAL No.)	原箱/原箱号(ORIGINAL/ORIGINAL CNTR. No.)															
货物(CARGO W.)	出场目的/状态(PPS OF GATE-OUT/STATUS)	进场目的/状态(PPS OF GATE-IN/STATUS)	出场日期(TIME-OUT) 月 日 时															
当场检查记录(INSPECTION AT THE TIME OF INTERCHANGE)																		
普通集装箱(GP. CNTR.)	冷藏集装箱(RK)	特种集装箱(SPL. CNTR.)	发电机(GEN. SET)															
<input type="checkbox"/> 正常(SOUND) <input type="checkbox"/> 异常(DEFFECTIVE)	<input type="checkbox"/> 正常(SOUND) 设定温度(SET) <input type="checkbox"/> 异常(DEFFECTIVE) 记录温度(RECORDED)	<input type="checkbox"/> 正常(SOUND) <input type="checkbox"/> 异常(DEFFECTIVE)	<input type="checkbox"/> 正常(SOUND) <input type="checkbox"/> 异常(DEFFECTIVE)															
损坏记录及代号(DAMAGE CODE)																		
<table border="0"> <tr> <td>BR 破损 (BROKEN)</td> <td>D 凹痕 (DENT)</td> <td>M 丢失 (MISSING)</td> <td>DR 污损 (DIRTY)</td> <td>DL 危标 (DGLABEL)</td> </tr> <tr> <td>左箱(LLEFT SIDE) </td> <td>右箱(RRIGHT SIDE) </td> <td>前箱(FRONT) </td> <td colspan="2">内部(INSIDE) </td> </tr> <tr> <td>顶部(TOP) </td> <td>底部(FLOOR BASE) </td> <td>后箱(REAR) </td> <td colspan="2">如有异常,请注明程度及尺寸(REMARK)</td> </tr> </table>				BR 破损 (BROKEN)	D 凹痕 (DENT)	M 丢失 (MISSING)	DR 污损 (DIRTY)	DL 危标 (DGLABEL)	左箱(LLEFT SIDE) 	右箱(RRIGHT SIDE) 	前箱(FRONT) 	内部(INSIDE) 		顶部(TOP) 	底部(FLOOR BASE) 	后箱(REAR) 	如有异常,请注明程度及尺寸(REMARK)	
BR 破损 (BROKEN)	D 凹痕 (DENT)	M 丢失 (MISSING)	DR 污损 (DIRTY)	DL 危标 (DGLABEL)														
左箱(LLEFT SIDE) 	右箱(RRIGHT SIDE) 	前箱(FRONT) 	内部(INSIDE) 															
顶部(TOP) 	底部(FLOOR BASE) 	后箱(REAR) 	如有异常,请注明程度及尺寸(REMARK)															
除列明者外,集装箱设备交接时完好无损,箱封完整无误。 EQUIPMENT INTERCHANGED IN SOUND CONDITION AND SEAL INTACT UNLESS OTHERWISE STATED		CONTAINER EQ																
用箱人/运箱人签署 (CONTAINER USER/HAULIER'S SIGNATURE)		用箱人/运箱人签署 (CONTAINER USER/HAULIER'S SIGNATURE)																
____ 日		____ 年 ____ 月 ____ 日																
GB/T 16561—1996 格式印刷																		











--	--	--	--	--	--

















--	--	--



--	--	--	--	--	--





--	--	--	--	--	--

--	--	--	--	--	--	--	--

○











\*6















--	--	--











--	--	--	--	--	--

○

○

○



○







#### 四、 快递物流作业组织与管理模块























--	--	--	--	--	--

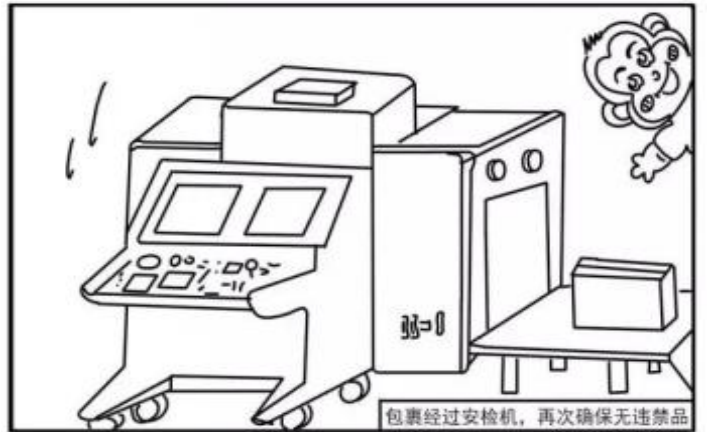

出示身份证件实名信息录入，确保信息安全



包裹经过安检机，再次确保无违禁品



宅急送，致力于成为中国最有价值的综合物流服务商



--	--	--	--	--	--















---





--	--	--	--	--	--



[想知道:中国成都理工大学校园快递具体在哪? 百度知道](#)

3个回答 - 提问时间: 2014年02月10日

最佳答案: 韵达在银杏后面。宝盒、圆通、顺丰在电影院后面。中通、申通在图书馆下面。常用的是这几个。

[zhidao.baidu.com/link?... 2014-02-15](#) - 百度快照 - 80%好评



















--	--	--	--











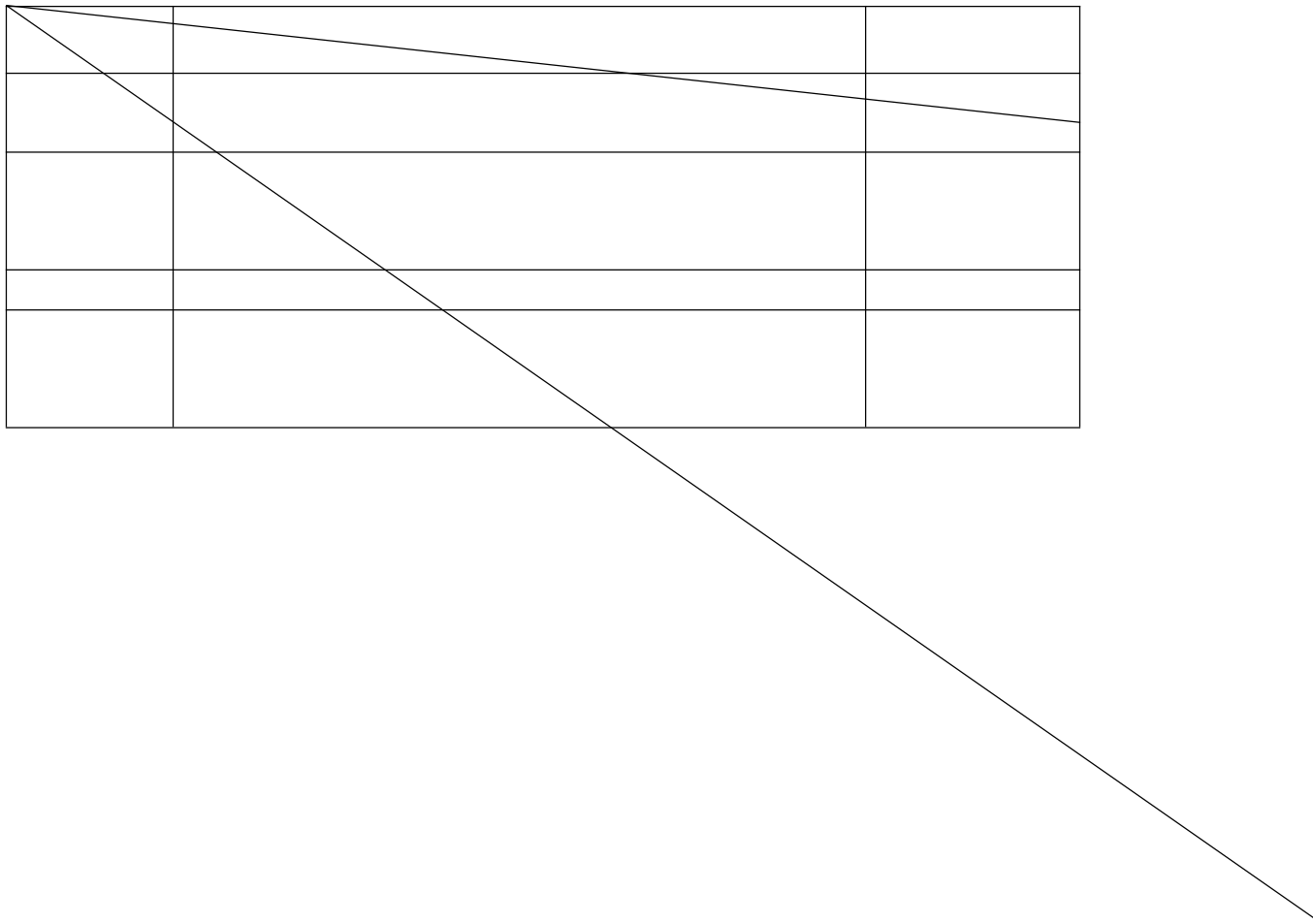









--	--	--	--















































































<hr/>
-------

